

**Features:**

- Hybrid Integrated Circuit
- Surface Mounted Device Type
- Shield Case : Nickel Silver
- 16PIN Type



**Electrical Specifications (T<sub>A</sub>=+25Deg.C, 50Ω system)**

NO	ITEM	UNIT	VALUE
1	Operating Frequency Range	MHz	1185 ~ 1215
2	Output Power Level	dBm	+3 ± 2
3	Harmonics Level (2 <sup>nd</sup> )	dBc	-20
4	Spurious Level	dBc	-85
5	Phase Noise at offset @ 1kHz at offset @ 10kHz at offset @ 100kHz at offset @ 1000kHz	dBc/Hz dBc/Hz dBc/Hz dBc/Hz	-80 -108 -125 -145
6	Load Impedance	Ω	50
7	Input Capacitance	pF	27
8	Tuning Voltage	V	+0.5 ~ +5.0
9	Tuning Sensitivity (Typ.)	MHz/V	20
10	Supply Voltage	Vdc	+5±0.25
11	Current Consumption (Typ.)	mA	20
12	Pushing	MHz/V	< 1.0
13	Pulling (VSWR = 1.5 : 1 All phase)	MHz	< 1.5
14	3dB Modulation Bandwidth.	MHz	40 Typ.
15	Operating Temp. Range	°C	-40 ~ +85

**Dimensions**

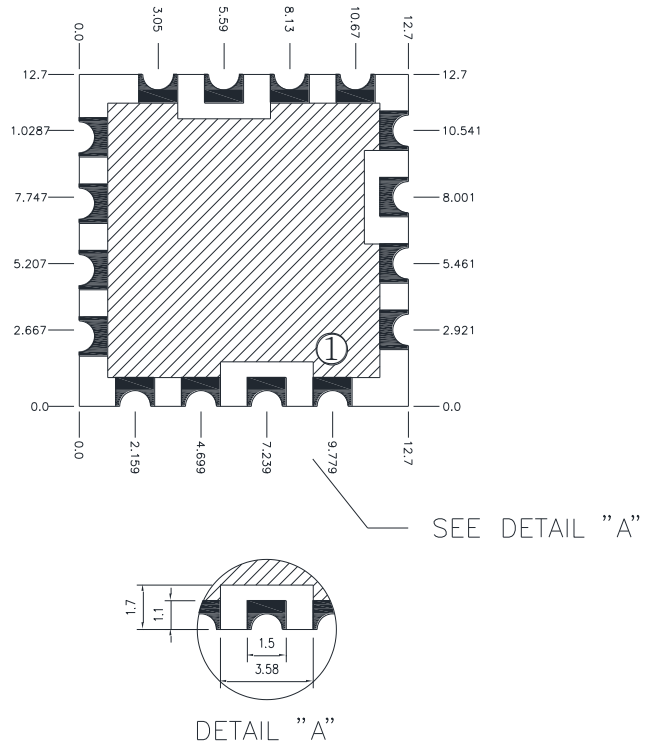
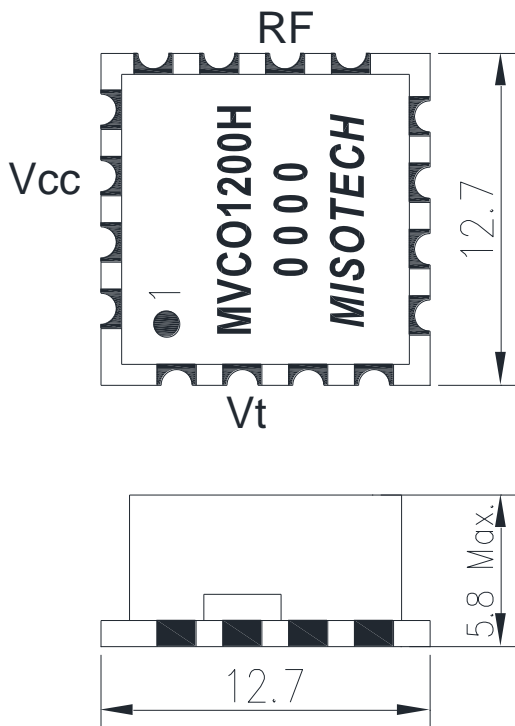

[ Unit : mm ]

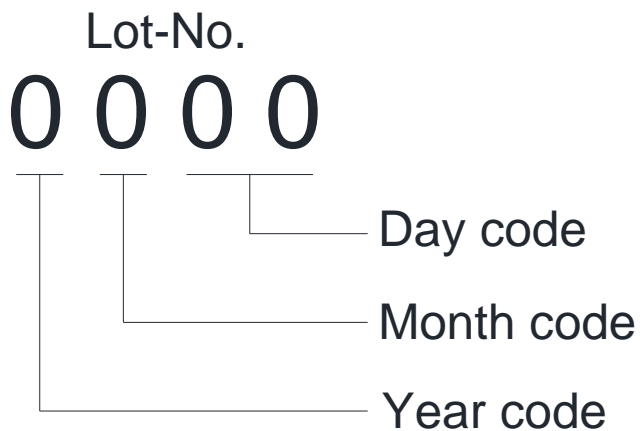

Terminal Connection	
Pin NO	Terminal NAME
2	Control Voltage
10	RF Output
14	Power Supply
All Other Pins are Ground	

**Packing**



**Taping**



REEL	TYPE	COLOR	HUB	SIZE
	PLASTIC	흑,백색	80	330
SHEET	KDS-BK 24mmX0.3t	POCKET COUNTER	750 POCKET	

**REEL DIMENSION**

**Reel**